



SUNBLOC™

SHUTTER & LOUVRE SYSTEMS

SUNBLOC FIXED LOUVRES



@ Sydney: sales.sydney@sunbloc.sydney.com.au

@ Brisbane: sales.brisbane@sunbloc.com.au

@ Perth: sales.perth@sunbloc.com.au

@ Newcastle: sales.newcastle@sunbloc.com.au

@ Melbourne: sales.melbourne@sunbloc.com.au

 www.sunbloc.com.au

SUNBLOC

FIXED LOUVRES

Overview

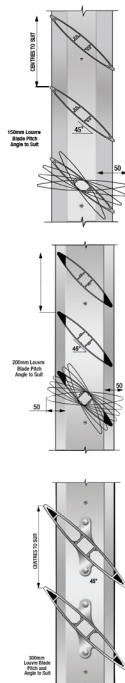

FIXED LOUVRES 90MM

Fixed Louvre 90mm	1
Fixed Louvre 90mm Section Details	2
Fixed Louvre 90mm (Horizontal Mount)	3
Fixed Louvre 90mm (Vertical Mount)	4
Fixed Louvre 90mm Elliptical Blade	5
Fixed Louvre 90mm Batten Blade	6

FIXED LOUVRES 150MM

Fixed Louvre 150mm Section Details	7
Fixed Louvre 150mm	8

FIXED LOUVRES 200MM

Fixed Louvre 200mm Section Details	9
Fixed Louvre 200mm	10

FIXED LOUVRES 300MM

Fixed Louvre 300mm Section Details	11
Fixed Louvre 300mm	12

FIXED LOUVRES EXTRUSION BLADE

Fixed Louvre Extrusions Blade Options	13
Various sizes and shapes from 45mm up to 300mm and Custom shape & sizes	

Project Applications

- Ventilation Screens
- Privacy Screens
- Carpark Screens
- Wall & Partitions
- Sun Shading
- Plant Room

and many more single or combined applications with diferent fixing methods available



www.sunbloc.com.au

SUNBLOC

FIXED LOUVRES

Fixed Louvre 90mm

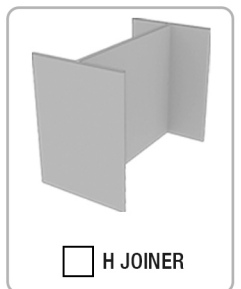
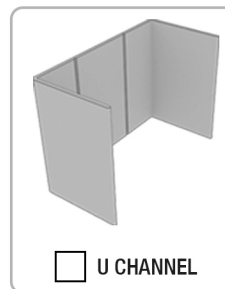
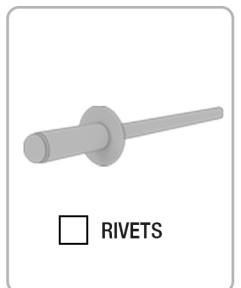
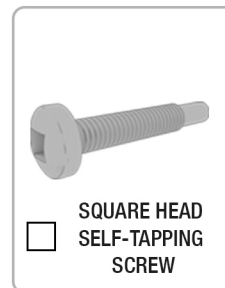
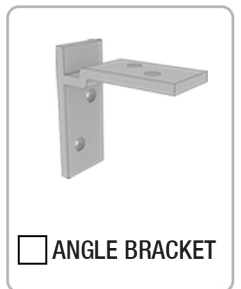
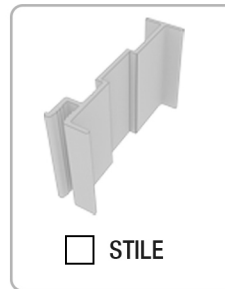
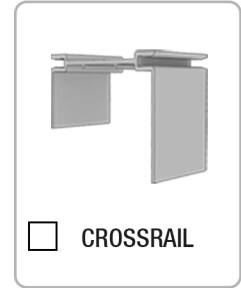

SUNBLOCTM
SHUTTER & LOUVRE SYSTEMS

 www.sunbloc.com.au

SUNBLOC

FIXED LOUVRES

Fixed Louvres 90mm Section Details

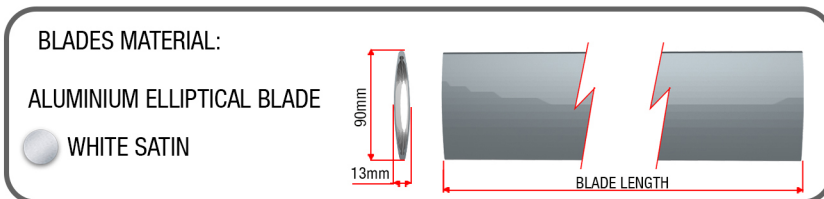
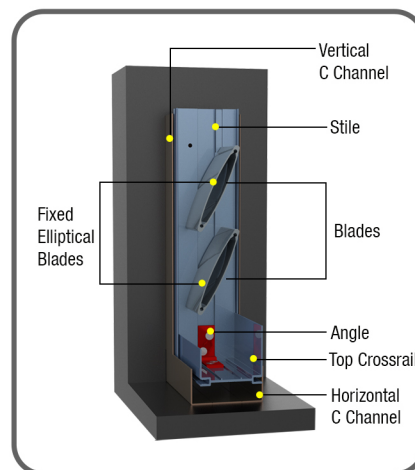
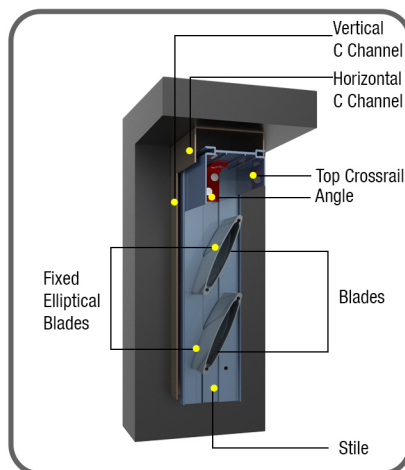
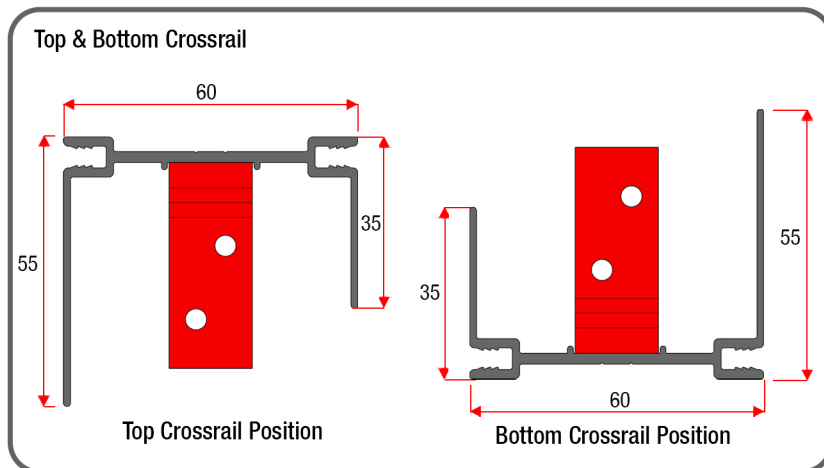
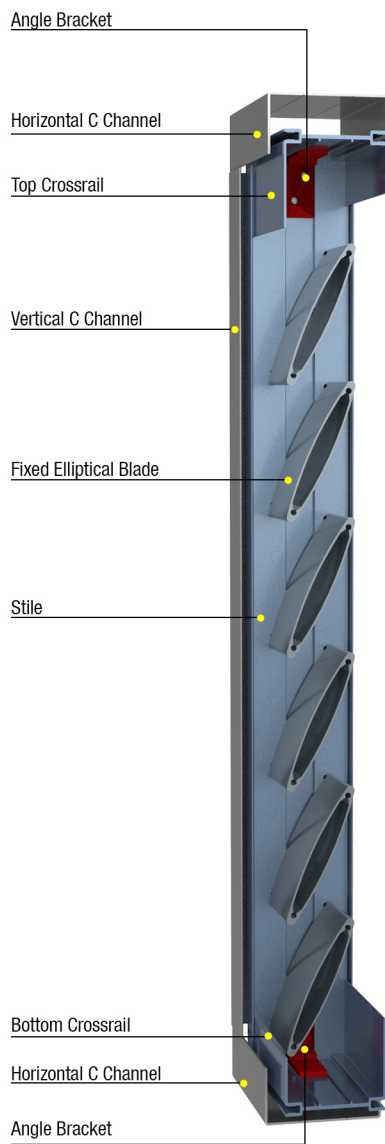

SUNBLOCTM
SHUTTER & LOUVRE SYSTEMS



www.sunbloc.com.au





SUNBLOC

FIXED LOUVRES

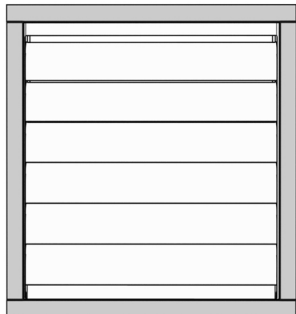
Fixed Louvres 90mm (Horizontal Mount)



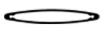

SINGLE BAY

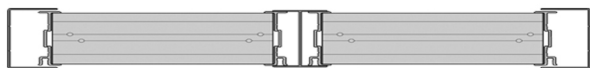
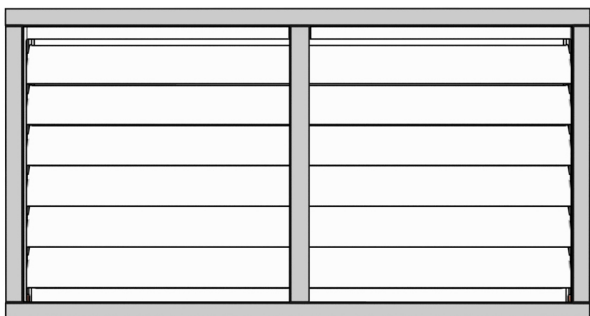

 2x U CHANNEL	 2x STILE	 2x CROSSRAIL	 ELLIPTICAL BLADE 6x (600 x 1200 mm) 20x (1800 x 1200 mm)	 4x ANGLE BRACKET
---	---	---	---	---



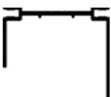

TWO BAYS

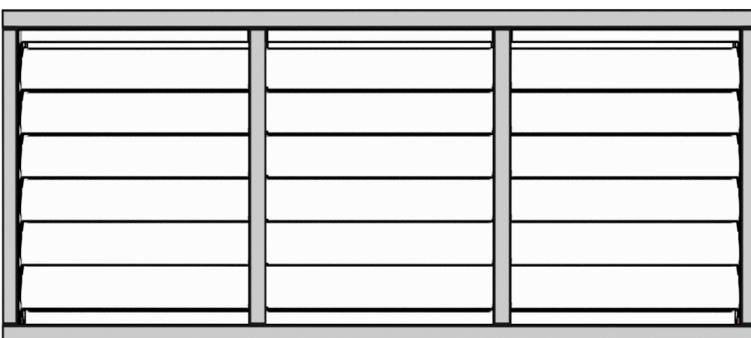

 2x U CHANNEL	 1x H JOINER	 4x STILE
 4x CROSSRAIL	 ELLIPTICAL BLADE 12x (600 x 1200 mm) 40x (1800 x 1200 mm)	 4x ANGLE BRACKET

THREE BAYS

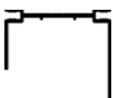

 2x U CHANNEL	 2x H JOINER	 6x STILE
 6x CROSSRAIL	 ELLIPTICAL BLADE 18x (600 x 1200 mm) 60x (1800 x 1200 mm)	 4x ANGLE BRACKET



SUNBLOCTM
SHUTTER & LOUVRE SYSTEMS



www.sunbloc.com.au





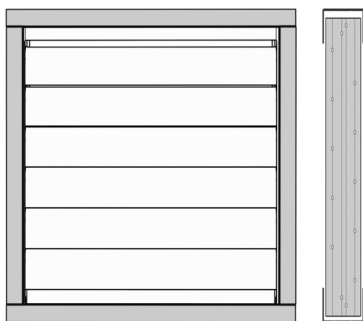

SUNBLOC

FIXED LOUVRES

Fixed Louvres 90mm (Vertical Mount)







SINGLE STACK

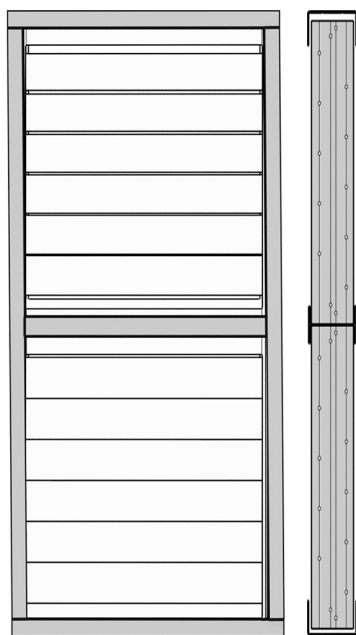

 2x U CHANNEL	 1x H JOINER	 2x STILE
 2x CROSSRAIL	 ELLIPTICAL BLADE 6x (600 x 1200 mm) 20x (1800 x 1200 mm)	 4x ANGLE BRACKET







TWO STACK

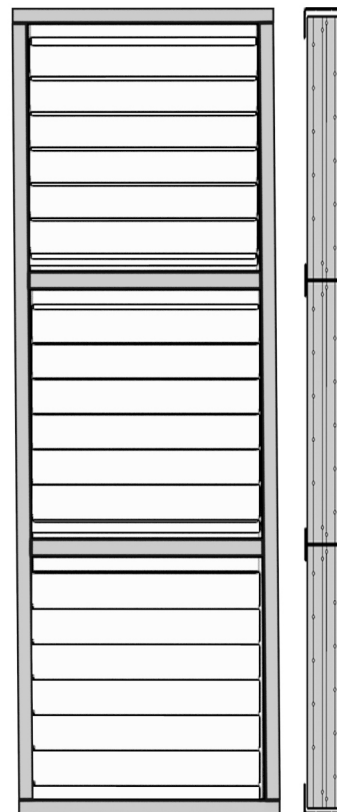

 2x U CHANNEL	 1x H JOINER	 4x STILE
 4x CROSSRAIL	 ELLIPTICAL BLADE 12x (600 x 1200 mm) 40x (1800 x 1200 mm)	 4x ANGLE BRACKET

THREE STACK



 2x U CHANNEL	 2x H JOINER	 6x STILE
 6x CROSSRAIL	 ELLIPTICAL BLADE 18x (600 x 1200 mm) 60x (1800 x 1200 mm)	 4x ANGLE BRACKET



SUNBLOCTM
SHUTTER & LOUVRE SYSTEMS



www.sunbloc.com.au

SUNBLOC

FIXED LOUVRES

Fixed Louvres 90mm Elliptical Blade

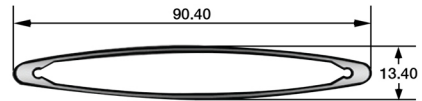

Fixed louvre ventilation screens for this gaming room



SUNBLOCTM
SHUTTER & LOUVRE SYSTEMS

 www.sunbloc.com.au

SUNBLOC

FIXED LOUVRES

Fixed Louvres 90mm Full Batten Blade

Fixed louvre 90mm Batten Blade Gate & Screens for this residential ground level carpark

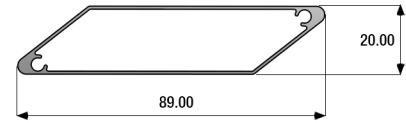

ow Clearance 2.16m



SUNBLOCTM
SHUTTER & LOUVRE SYSTEMS



www.sunbloc.com.au

SUNBLOC

FIXED LOUVRES

Fixed Louvres 150mm Section Details

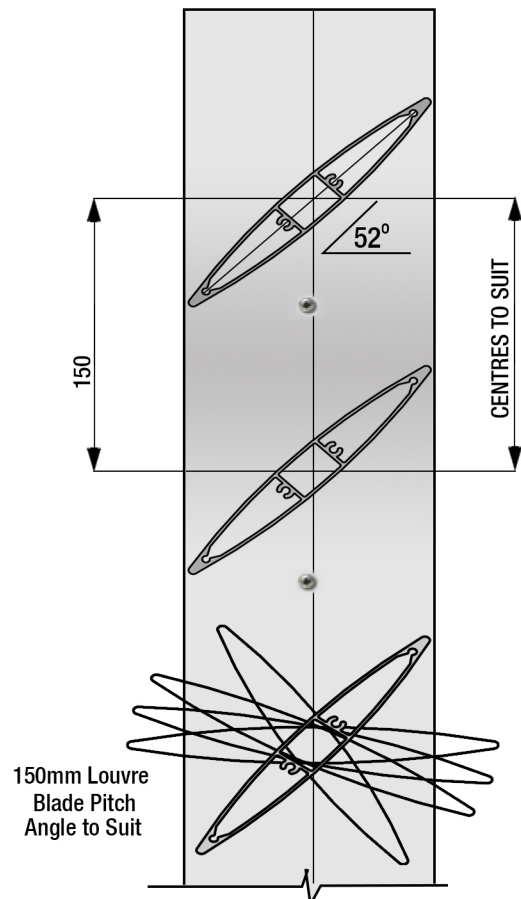
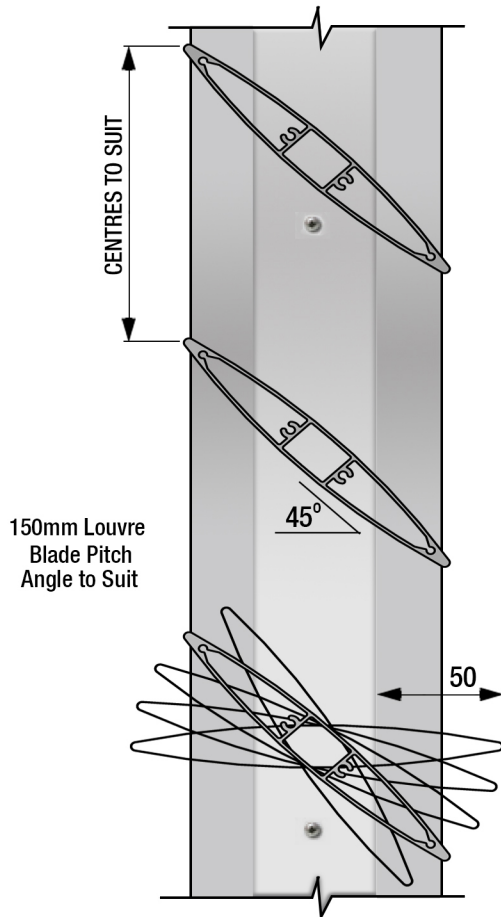
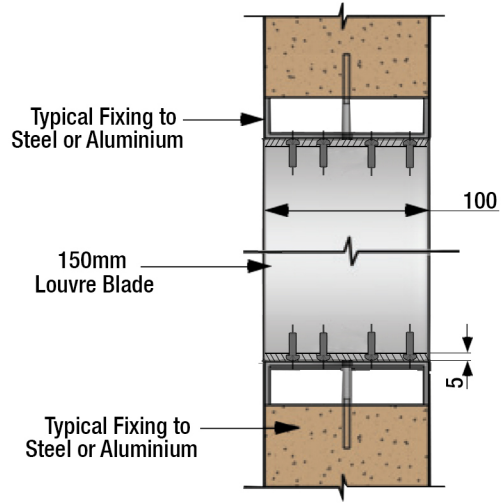
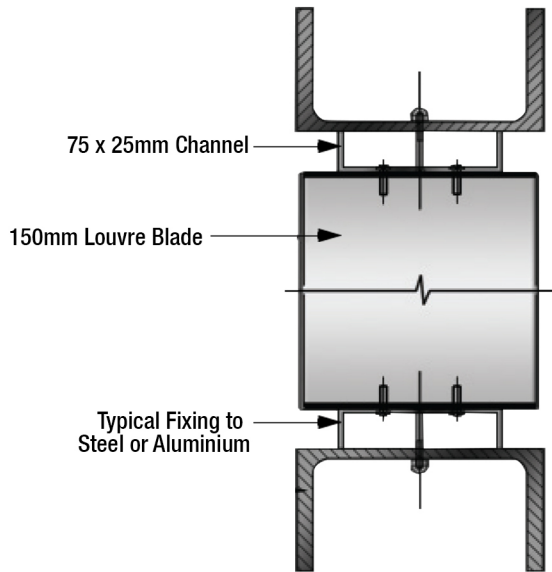

SUNBLOCTM
SHUTTER & LOUVRE SYSTEMS



www.sunbloc.com.au

SUNBLOC

FIXED LOUVRES

Fixed Louvres 150mm

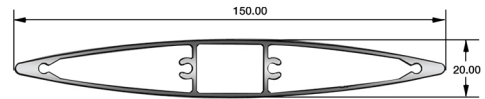

blade used here to privatise the neighbour sides of this architect designed private residence.



SUNBLOC[™]
SHUTTER & LOUVRE SYSTEMS



www.sunbloc.com.au

SUNBLOC

FIXED LOUVRES

Fixed Louvres 200mm Section Details

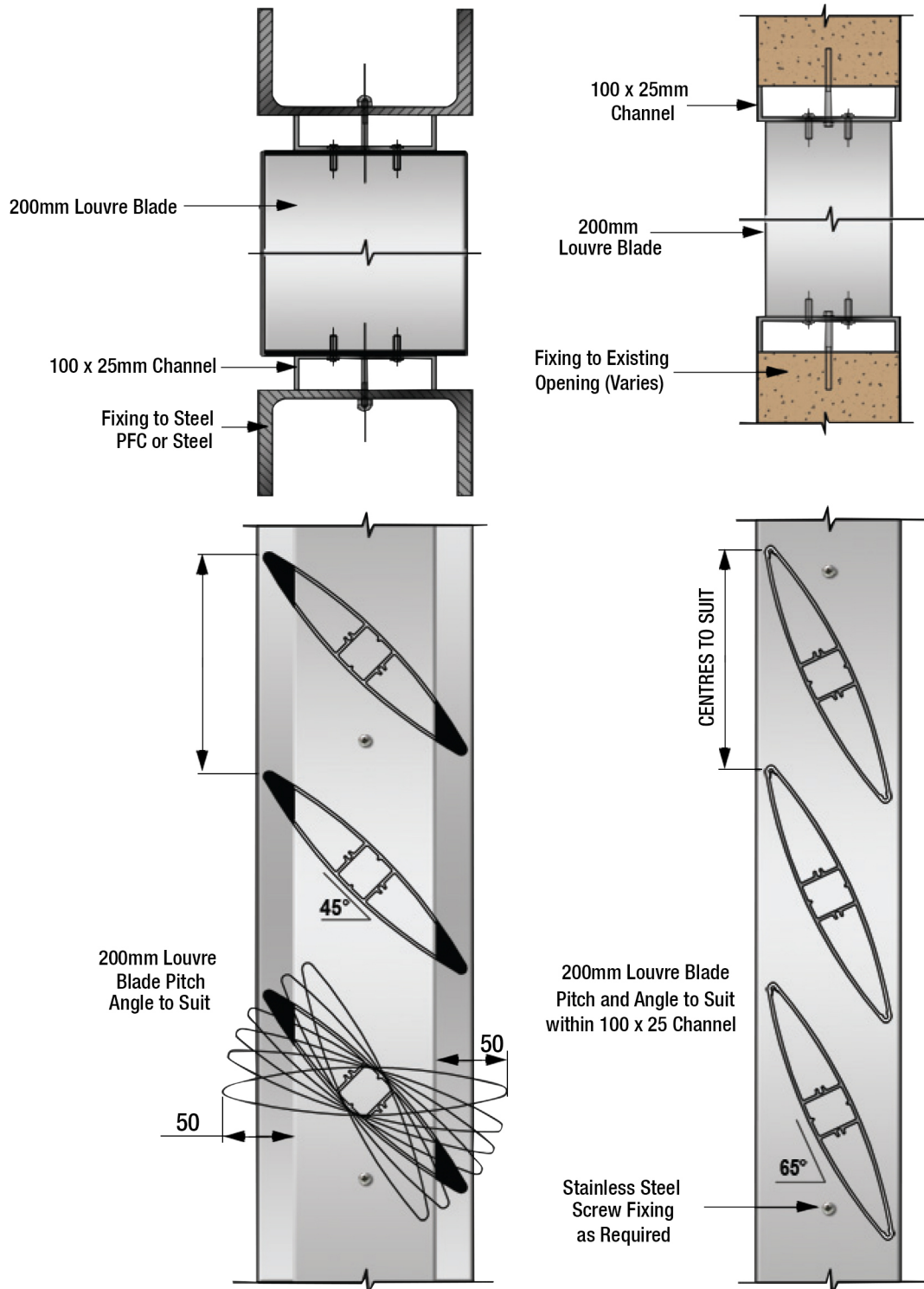

SUNBLOC™
SHUTTER & LOUVRE SYSTEMS



www.sunbloc.com.au

SUNBLOC

FIXED LOUVRES

Fixed Louvres 200mm

200mm louvre blade shades the front of this commercial building.

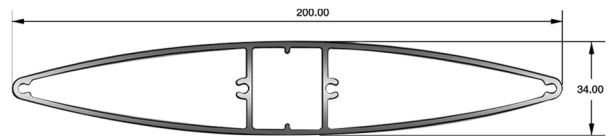

SUNBLOCTM
SHUTTER & LOUVRE SYSTEMS

 www.sunbloc.com.au

SUNBLOC

FIXED LOUVRES

Fixed Louvres 300mm Section Details

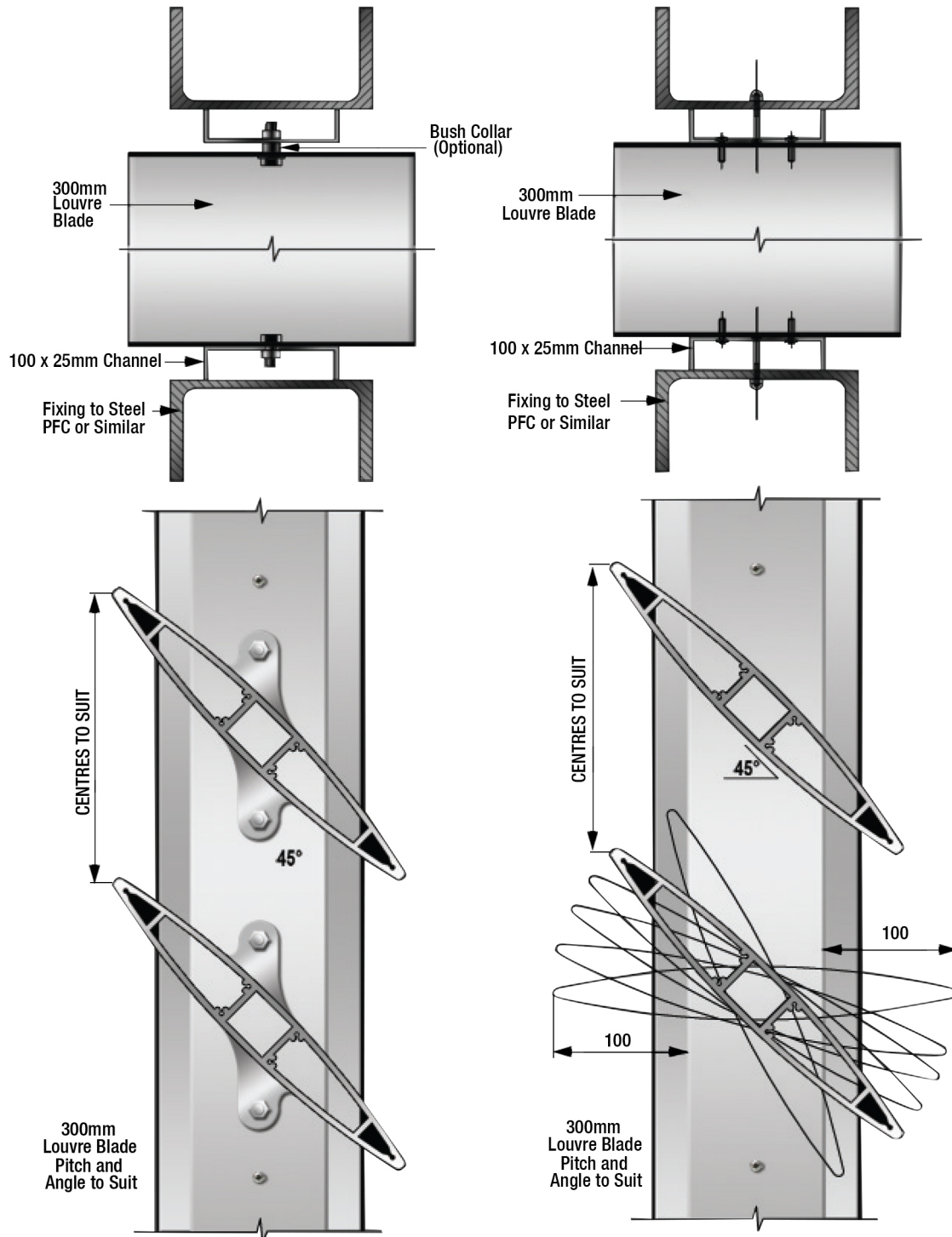

SUNBLOCTM
SHUTTER & LOUVRE SYSTEMS



www.sunbloc.com.au

SUNBLOC

FIXED LOUVRES

Fixed Louvres 300mm

300mm louvre blade shades the front of this residential building.

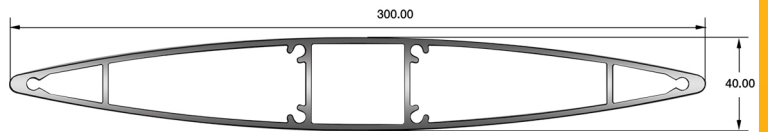

SUNBLOC[™]
SHUTTER & LOUVRE SYSTEMS



www.sunbloc.com.au

SUNBLOC

FIXED LOUVRES

Fixed Louvres Extrusions Blade Options

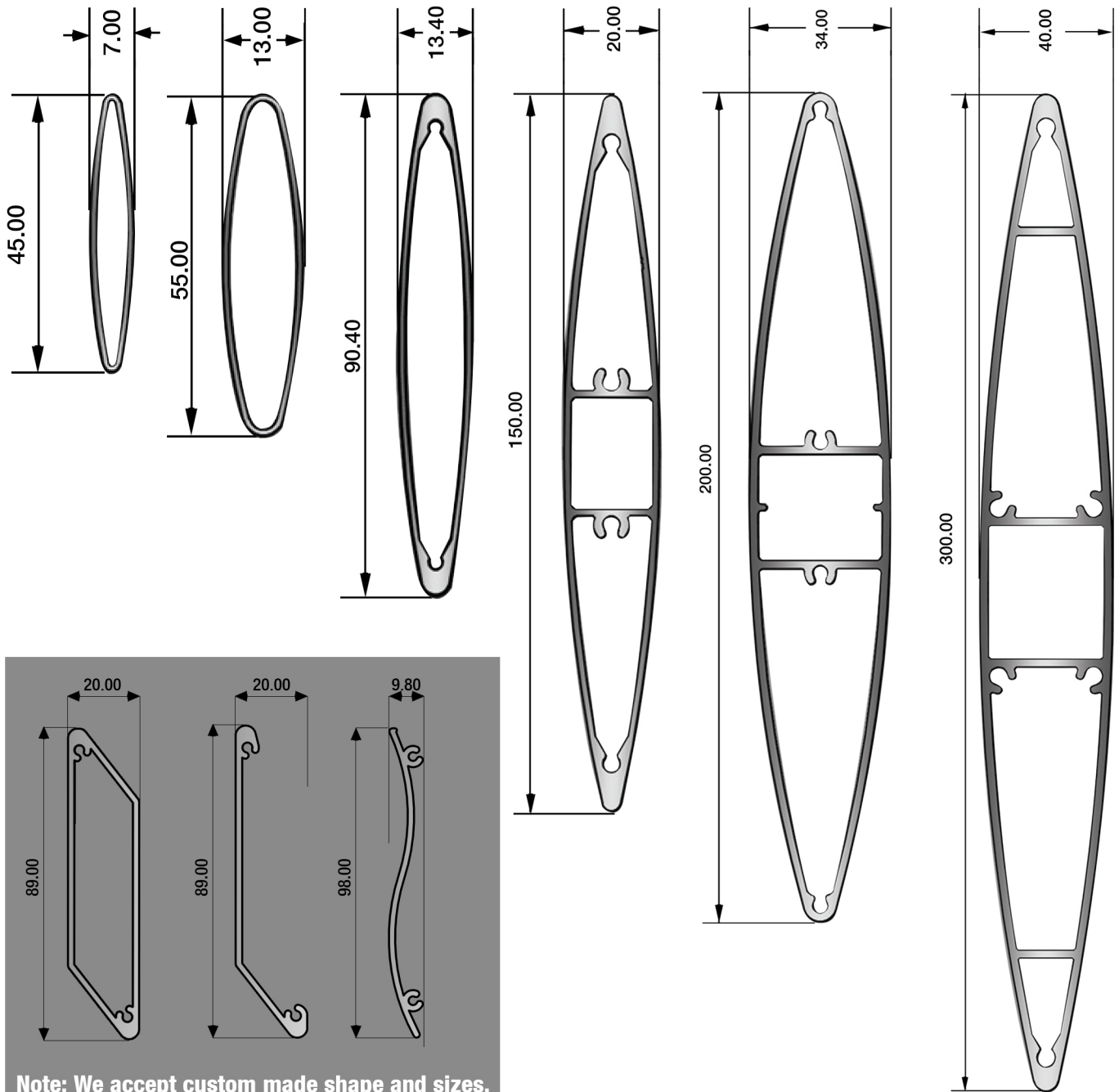

Note: We accept custom made shape and sizes.



SUNBLOC[™]
SHUTTER & LOUVRE SYSTEMS



www.sunbloc.com.au



SUNBLOC™

SHUTTER & LOUVRE SYSTEMS

CONTACT YOUR NEAREST BRANCH

Brisbane

Address: 1/43 Raubers Road Northgate QLD 4013
Email: sales.brisbane@sunbloc.com.au

Sydney

Address: 1/26-28 Redfern St Wetherill Park NSW 2164
Email: sales.sydney@sunbloc.sydney.com.au

Perth

Address: 35 Edison Circuit, Forrestdale WA 6112
Email: sales.perth@sunbloc.com.au

Newcastle

Address: 119 Glenwood Drive Thornton NSW 2322
Email: sales.newcastle@sunbloc.com.au

Melbourne

Address: 26 Evolution Drive, Dandenong South VIC 3175
Email: sales.melbourne@sunbloc.com.au



www.sunbloc.com.au

Head Office



1/26-28 Redfern St Wetherill
Park NSW 2164



02 8729 0680



head.office@sunbloc.com.au